

EXTRALUM

EXTRUSIÓN DE PERFILES DE ALUMINIO

www.extralum.com.ar









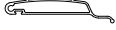

LÍNEA E45

COD.	DESCRIPCIÓN	DISEÑO	APLICACIÓN	PESO KG/M	PESO PACK	LARGO	PÁGINA
100	MARCO CORREDIZA LIVIANO		VENTANA	0,584	X6: 21,200	6,05	8
101	MARCO CORREDIZA REFORZADO		VENTANA	0,742	X6: 26,900	6,05	8
102-1	CABEZAL Y ZÓCALO DE HOJA REFORZADO		VENTANA	0,448	X6: 16,300	6,05	8
102	CABEZAL Y ZÓCALO DE HOJA		VENTANA	0,382	X6: 13,900	6,05	9
103	PARANTE LATERAL HOJA CORREDIZA		VENTANA	0,397	X8: 19,200	6,05	9
104	PARANTE CENTRAL HOJA CORREDIZA		VENTANA	0,372	X8: 18,000	6,05	9
105	HOJA MOSQUITERO		VENTANA	0,278	X14: 23,500	6,05	10
261	REVESTIMIENTO ACANALADO		PUERTA	0,278	X8: 13,500	6,05	10
263	REVESTIMIENTO TUBULAR		PUERTA	0,653	X6: 23,700	6,05	10
280	TABLILLA CURVA POSTIGÓN		VENTANA	0,254	X16: 24,600	6,05	12
417	TABLILLA CURVA CON TOPE		VENTANA	0,293	X12: 21,300	6,05	12
418	TABLILLA RECTA POSTIGÓN		VENTANA	0,263	X15: 23,900	6,05	12

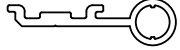
REFERENCIAS: COD: CÓDIGO | PESO PACK: PESO KG/M POR X UNIDADES | LARGO: LARGO DE BARRA EN METROS

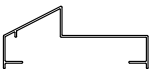

LÍNEA E45

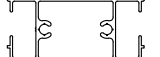
COD.	DESCRIPCIÓN	DISEÑO	APLICACIÓN	PESO KG/M	PESO PACK	LARGO	PÁGINA
7559	TABLILLA CORTINA BARRIO		VENTANA	0,521	X6: 19,400	6,20	13
6307	TABLILLA CORTINA DE ENROLLAR		VENTANA	0,421	X8: 20,900	6,20	13
843	BISAGRA VENTANA		VENTANA	0,611	X6: 22,200	6,05	13
844	BISAGRA PUERTA		PUERTA	0,621	X6: 22,500	6,05	14
MP25	MARCO PUERTA 25		PUERTA	0,525	X6: 19,500	6,20	14
768	MARCO RECTO DE 25		PUERTA	0,602	X6: 22,400	6,20	14
MP36	MARCO PUERTA 36		PUERTA	0,536	X6: 19,900	6,20	17
MPP46	MARCO PUERTA PLACA 46		PUERTA	0,355	X10: 22,000	6,20	17
PP25	PARANTE POSTIGON 25		PUERTA	0,640	X6: 23,800	6,20	17
PP36	PARANTE PUERTA 36 ARMADO A 45°		PUERTA	0,980	X4: 24,300	6,20	18
TP36	TRAVESAÑO DE PUERTA 36		PUERTA	1,045	X4: 25,300	6,05	18

REFERENCIAS: COD: CÓDIGO | PESO PACK: PESO KG/M POR X UNIDADES | LARGO: LARGO DE BARRA EN METROS



LÍNEA E45

COD.	DESCRIPCIÓN	DISEÑO	APLICACIÓN	PESO KG/M	PESO PACK	LARGO	PÁGINA
178	PARANTE POSTIGÓN CHICO		PUERTA	0,464	X8: 23,000	6,20	18
144	ZÓCALO ALTO PUERTA CORREDIZA		PUERTA	0,618	X6: 22,400	6,05	19
117	MARCO DE ALTO TRÁNSITO		PUERTA	1,066	X4: 25,800	6,05	19
107	MARCO PAÑO FIJO		VENTANA	0,524	X6: 19,000	6,05	19
108	CONTRAVIDRIO		VENTANA	0,151	X20: 18,300	6,05	20
161	MARCO AIREADOR		VENTANA	0,454	X8: 22,000	6,05	20
ESLI	ESCUADRA LIVIANA		VENTANA/ PUERTA	0,396	X6: 14,400	6,05	20
ESI	ESCUADRA INTERMEDIA		VENTANA/ PUERTA	0,591	X6: 21,500	6,05	21
30	CENTRAL VIDRIO REPARTIDO		VENTANA/ PUERTA	0,383	X10: 23,200	6,05	21
31	PERIMETRAL VIDRIO REPARTIDO		VENTANA/ PUERTA	0,265	X16: 25,700	6,05	21

REFERENCIAS: COD: CÓDIGO | PESO PACK: PESO KG/M POR X UNIDADES | LARGO: LARGO DE BARRA EN METROS









LÍNEA E90

COD.	DESCRIPCIÓN	DISEÑO	APLICACIÓN	PESO KG/M	PESO PACK	LARGO	PÁGINA
6200P	UMBRAL DINTEL REFORZADO		VENTANA	1,266	X4: 31,400	6,20	23
6201	JAMBA MARCO		VENTANA	0,670	X6: 24,900	6,20	23
6203	PARANTE LATERAL SIMPLE		VENTANA	0,700	X6: 26,000	6,20	23
6204	CABEZAL ZÓCALO SIMPLE		VENTANA	0,700	X6: 26,000	6,20	24
6205	PREMARCO		VENTANA	0,361	X12: 26,900	6,20	24
6206	TAPA JUNTAS		VENTANA	0,182	X12: 13,600	6,20	24
6207	PARANTE CENTRAL SIMPLE		VENTANA	0,613	X6: 22,800	6,20	25
6212	CONTRAVIDRIO 36MM		PUERTA	0,316	X12: 23,500	6,20	25
6213	PERFIL DE ACOPLA SIMPLE			0,248	X12: 18,500	6,20	25
6214	JAMBAS Y CABEZAL HOJA PUERTA DE REBATIR.		PUERTA	1,085	X4: 26,900	6,20	26
6215	HOJA VENTANA DE ABRIR DOBLE CONTACTO/BANDEROLA.		VENTANA	0,864	X4: 21,400	6,20	26

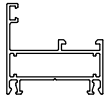
REFERENCIAS: COD: CÓDIGO | PESO PACK: PESO KG/M POR X UNIDADES | LARGO: LARGO DE BARRA EN METROS

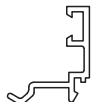
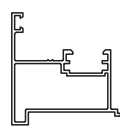

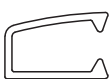
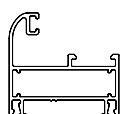
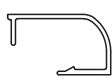
LÍNEA E90

COD.	DESCRIPCIÓN	DISEÑO	APLICACIÓN	PESO KG/M	PESO PACK	LARGO	PÁGINA
6216	MARCO VENT. DE ABRIR DC/BANDEROLA/ PUERTA REBATIR/VENTILUZ/PF RECTO.		VENTANA/ PUERTA	0,724	X6: 26,900	6,20	26
6217	CONTRAVIDRIO 29 MM		VENTANA	0,294	X12: 22,000	6,20	27
6218	TRAVESAÑO HOJA PUERTA DE REBATIR.		PUERTA	1,150	X4: 28,500	6,20	27
6220	CONTRAVIDRIO EXTERIOR PUERTA DE REBATIR.		PUERTA	0,173	X12: 12,800	6,20	27
6224	ENCUENTRO CENTRAL VENTANA DE ABRIR 2 HOJAS DC/PTA. DE REBATIR		VENTANA/ PUERTA	0,745	X4: 18,500	6,20	28
6225	CONTRAVIDRIO RECTO DE 22MM.		VENTANA	0,257	X12: 19,000	6,20	28
6226	CONTRAVIDRIO RECTO DE 15MM.		VENTANA	0,211	X12: 15,800	6,20	28
6228	TOPE MOSQUITERO VENTANA Y PUERTA CORREDIZA.		VENTANA/ PUERTA	0,178	X12: 13,200	6,20	30
6229	PAÑO FIJO CURVO		PAÑO FIJO	0,767	X4: 19,000	6,20	30
6230	CONTRAVIDRIO CURVO 29MM		VENTANA/ PUERTA	0,213	X12: 15,800	6,20	30
6232	CONTRAVIDRIO CURVO 22MM		VENTANA/ PUERTA	0,181	X12: 13,500	6,20	31

REFERENCIAS: COD: CÓDIGO | PESO PACK: PESO KG/M POR X UNIDADES | LARGO: LARGO DE BARRA EN METROS



LÍNEA E90

COD.	DESCRIPCIÓN	DISEÑO	APLICACIÓN	PESO KG/M	PESO PACK	LARGO	PÁGINA
6235	HOJA CURVA VENTANA DE ABRIR D.C./BANDEROLA.		VENTANA	0,829	X4: 20,600	6,20	31
6236	HOJA CURVA VENTILUZ		VENTANA	0,832	X4: 20,600	6,20	31
6237	CONTRAVIDRIO CURVO EXTERIOR PUERTA DE REBATIR		PUERTA	0,175	X12: 13,000	6,20	32
6243	GUÍA DE CORTINA COMÚN		VENTANA	0,532	X8: 26,400	6,20	32
6248	PARANTE LATERAL DE HOJA PARA DVH VENTANA Y PUERTA CORREDIZA.		VENTANA/ PUERTA	0,621	X6: 23,100	6,20	32
6249	ZÓCALO Y CABEZAL DE HOJA PARA DVH VENTANA Y PUERTA CORREDIZA.		VENTANA/ PUERTA	0,645	X6: 25,600	6,20	33
6250	PARANTE CENTRAL DE HOJA PARA DVH VENTANA Y PUERTA CORREDIZA.		VENTANA/ PUERTA	0,586	X6: 21,800	6,20	33
6255	BASTIDOR MOSQUITERO.		VENTANA	0,427	X10: 26,500	6,20	33
6256	TRAVESAÑO MOSQUITERO.		VENTANA	0,543	X6: 20,200	6,20	34

REFERENCIAS: COD: CÓDIGO | PESO PACK: PESO KG/M POR X UNIDADES | LARGO: LARGO DE BARRA EN METROS



LÍNEA E30

COD.	DESCRIPCIÓN	DISEÑO	APLICACIÓN	PESO KG/M	PESO PACK	LARGO	PÁGINA
6034	PARANTE LATERAL CORREDIZA		VENTANA	1,399	X2: 17,300	6,20	35
6035	PARANTE CENTRAL CORREDIZA		VENTANA	1,531	X2: 19,000	6,20	35
6036	JAMBAS DE MARCO		VENTANA/ PUERTA	0,891	X4: 22,100	6,20	35
6059	MARCO RECTO PAÑO FIJO Y VENTANA DE ABRIR		VENTANA/PF	1,053	X2: 13,100	6,20	36
6061	ZOCALO Y CABEZAL VENTANA CORREDIZA		VENTANA	0,926	X4: 23,000	6,20	36
6066	PREMARCO		VENTANA	0,545	X5: 16,900	6,20	36
6071	PARANTE LATERAL CORREDIZA PARA DVH		VENTANA	1,334	X2: 16,500	6,20	37
6072	PARANTE CENTRAL CORREDIZA PARA DVH		VENTANA	1,466	X2: 18,200	6,20	37
6073	ZÓCALO Y CABEZAL CORREDIZA PARA DVH		VENTANA	0,829	X4: 20,600	6,20	37

REFERENCIAS: COD: CÓDIGO | PESO PACK: PESO KG/M POR X UNIDADES | LARGO: LARGO DE BARRA EN METROS

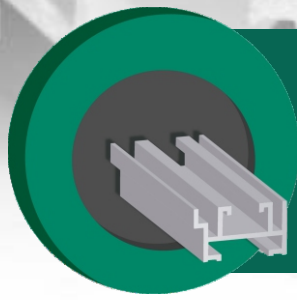

EXTRALUM

**LÍNEA
E
45**

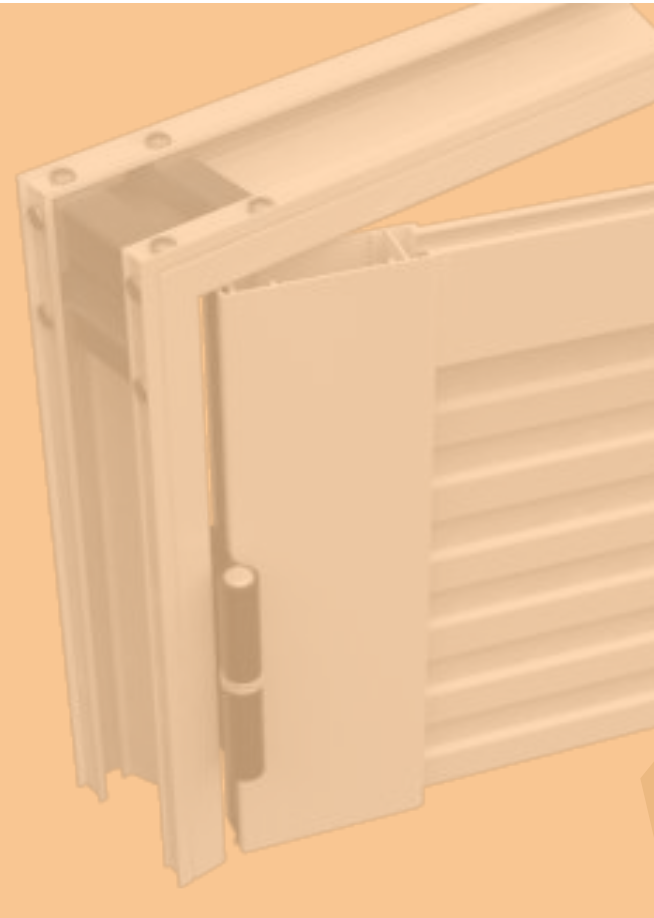

EXTRUSIÓN DE PERFILES DE ALUMINIO

MARCO DE CORREDIZA LIVIANO

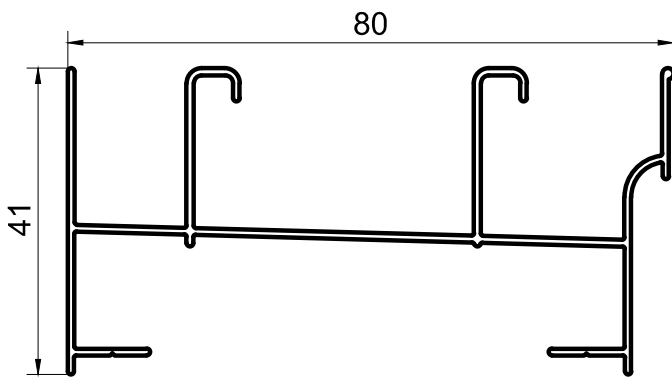

 100

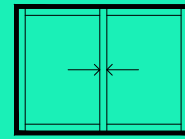

 0,584 KG/M

 X6: 21,200 KG

 6,05 M

MARCO DE CORREDIZA REFORZADO

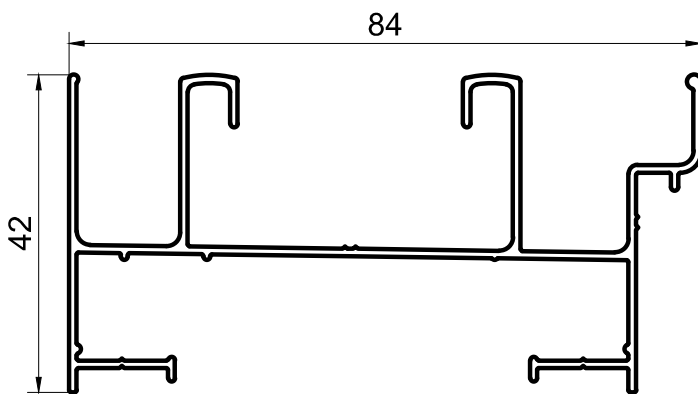

 101

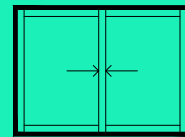

 0,742 KG/M

 X6: 26,900 KG

 6,05 M

CABEZAL Y ZÓCALO DE HOJA REFORZADO

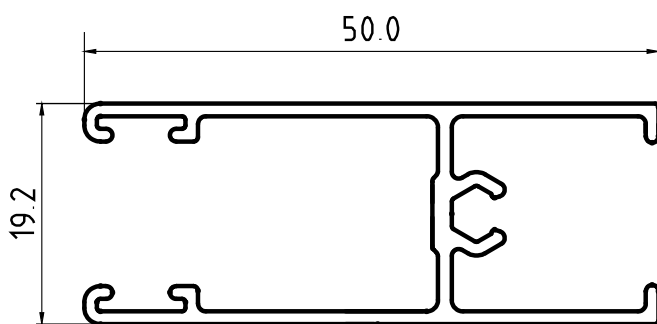

 102-1

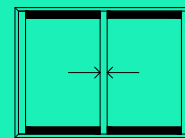



 0,448 KG/M

 X6: 16,300 KG

 6,05 M

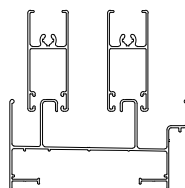
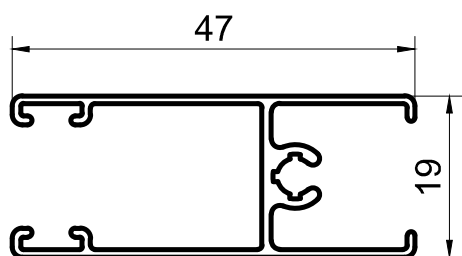
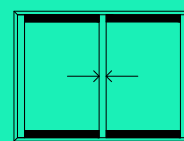
CABEZAL Y ZÓCALO DE HOJA



 102

 0,382 KG/M

 X6: 13,900 KG

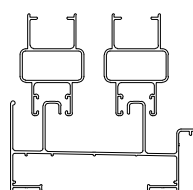
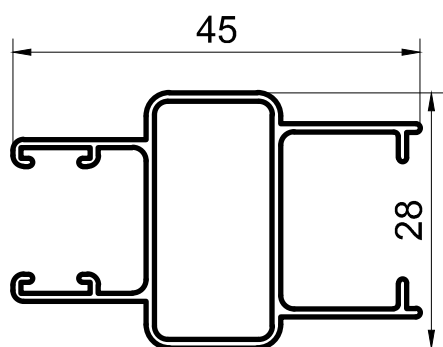
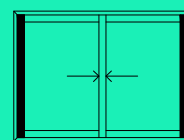
 6,05 M

PARANTE LATERAL HOJA CORREDIZA



 103

 0,397 KG/M

 X8: 19,200 KG

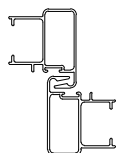
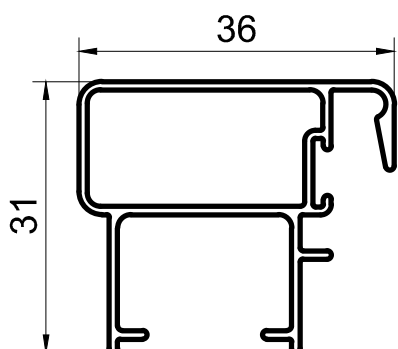
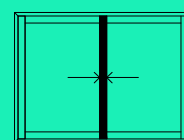
 6,05 M

PARANTE CENTRAL HOJA CORREDIZA



 104

 0,372 KG/M

 X8: 18,000 KG

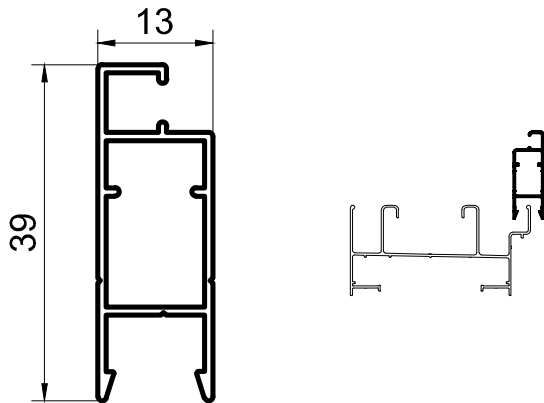
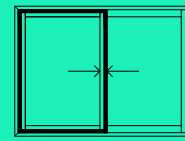
 6,05 M

HOJA MOSQUITERO



 105

 0,278 KG/M

 X14: 23,500 KG

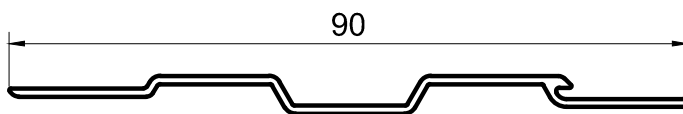
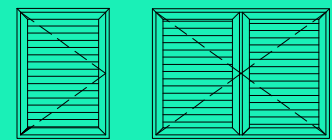
 6,05 M

REVESTIMIENTO ACANALADO

 261

 0,278 KG/M

 X8: 13,500 KG

 6,05 M

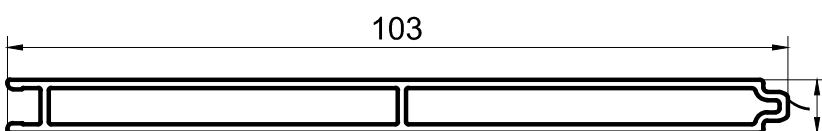
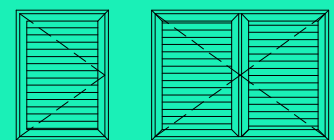
REVESTIMIENTO TUBULAR



 263

 0,653 KG/M

 X6: 23,700 KG

 6,05 M

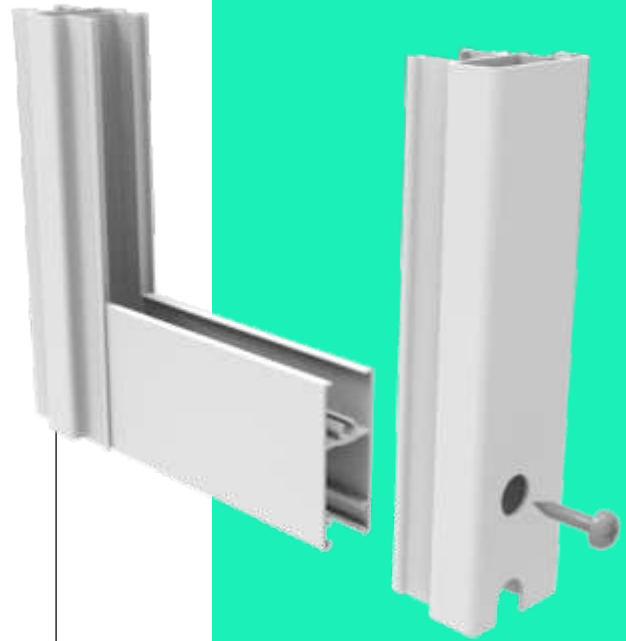

HOJA COMPLETA



HOJA ARMADO CON TORNILLOS

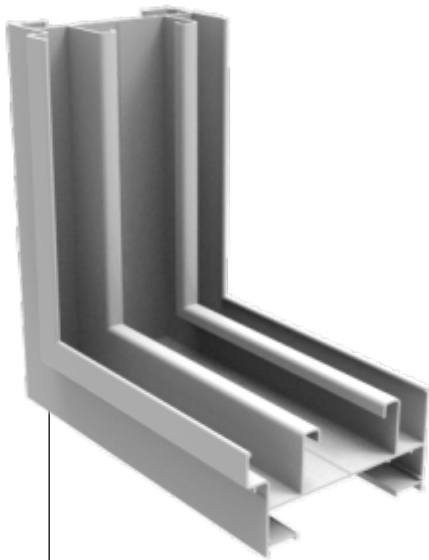

MARCO UNIÓN 45°

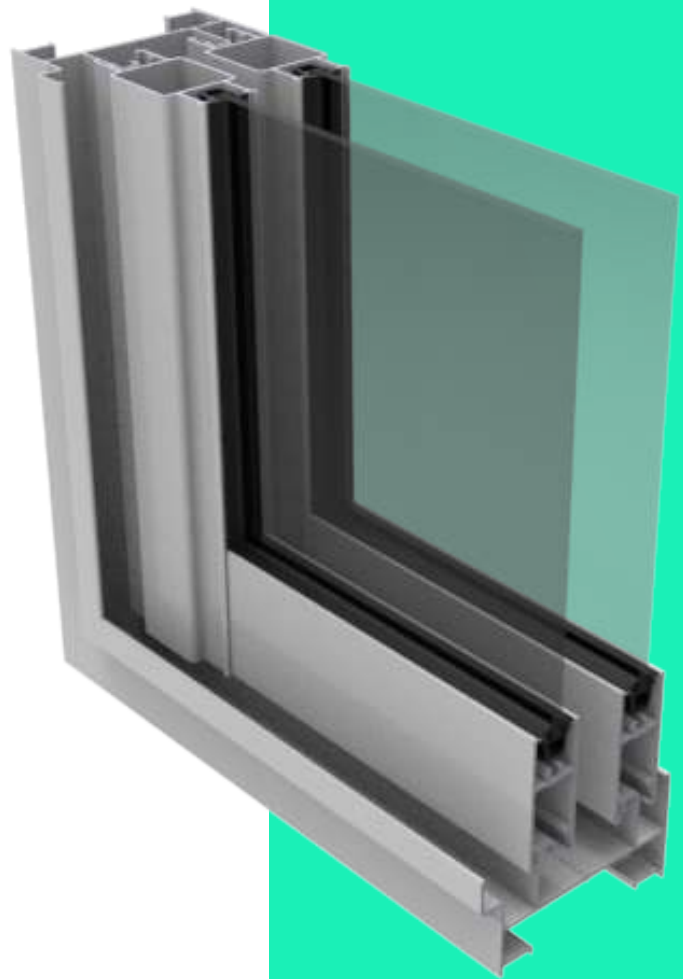

TABLILLA CURVA POSTIGÓN

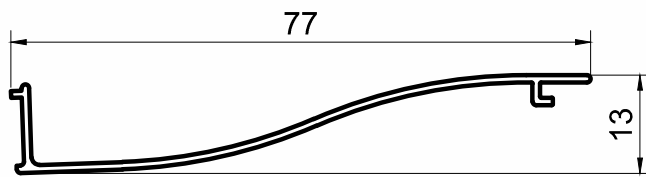

280

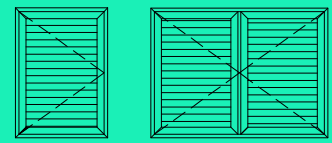

0,254 KG/M

X16: 24,600 KG

6,05 M

TABLILLA CURVA CON TOPE

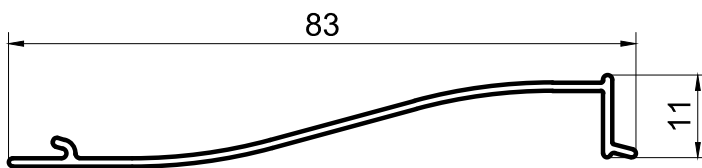

417

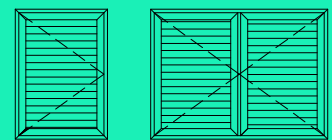

0,293 KG/M

X12: 21,300 KG

6,05 M

TABLILLA RECTA POSTIGÓN

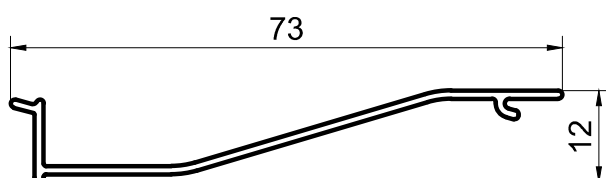

418

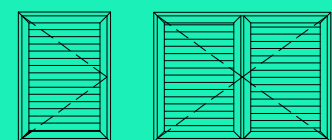



0,263 KG/M

X15: 23,900 KG

6,05 M

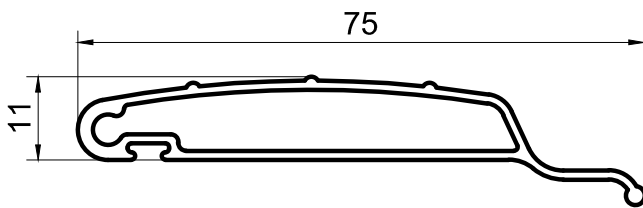
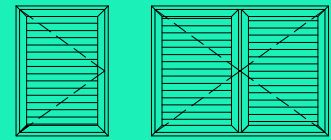
TABLILLA CORTINA BARRIO



 7559

 0,521 KG/M

 X6: 19,400 KG

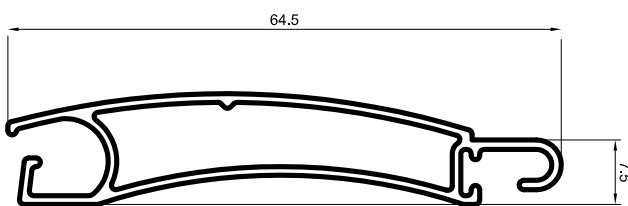
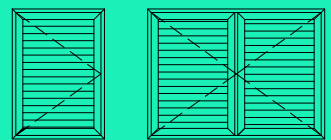
 6,20 M

TABLILLA CORTINA DE ENROLLAR



 6307

 0,421 KG/M

 X8: 20,900 KG

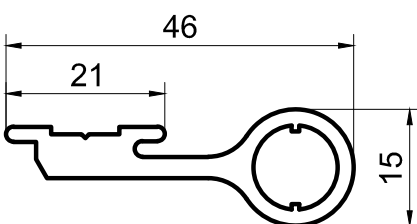
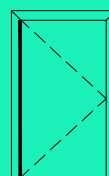
 6,20 M

BISAGRA VENTANA

 843

 0,611 KG/M

 X6: 22,200 KG

 6,05 M

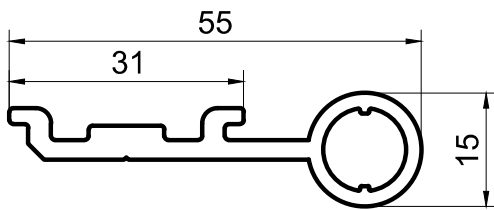
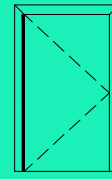
BISAGRA PUERTA



 844

 0,621 KG/M

 X6: 22,500 KG

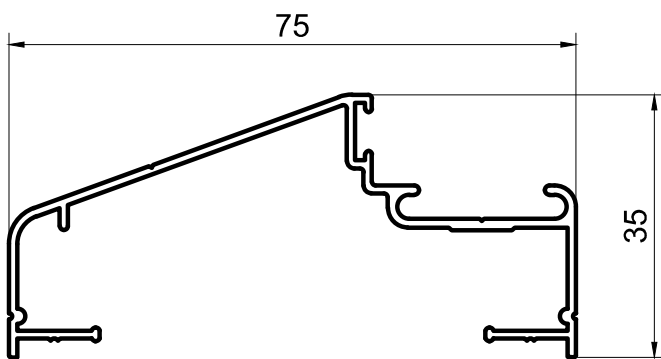
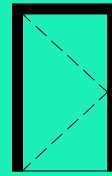
 6,05 M

MARCO PUERTA 25



 MP 25

 0,525 KG/M

 X6: 19,500 KG

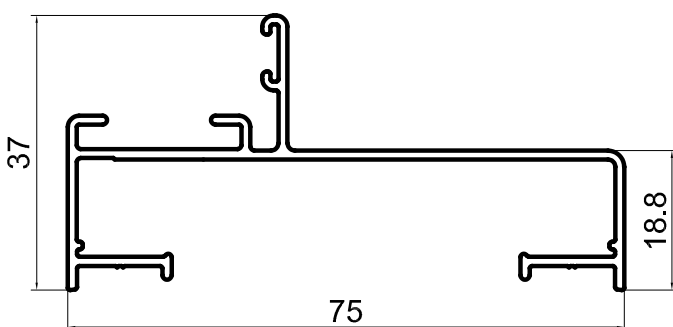
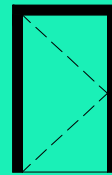
 6,20 M

MARCO RECTO DE 25

 768

 0,602 KG/M

 X6: 22,400 KG

 6,20 M

EJEMPLO DE CONSTRUCCIÓN CON
REVESTIMIENTOS DE TABLILLAS

TRAVESAÑO



CONJUNTO DE TABLILLA
CORTINA





CONJUNTO
REVESTIMIENTO
REFORZADO

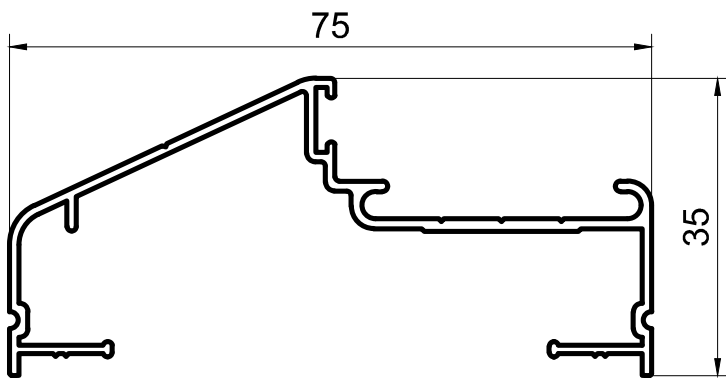
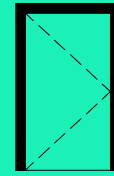

CONSULTE
POR PEDIDOS
DE PERFILES
ESPECIALES

MARCO PUERTA 36



 MP 36

 0,536 KG/M

 X6: 19,900 KG

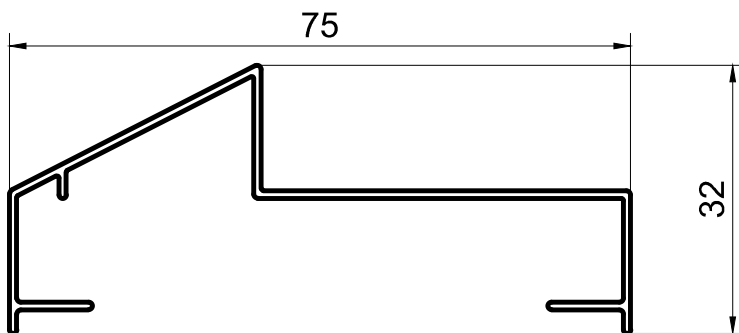
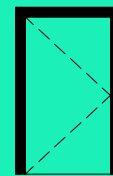
 6,20 M



MARCO PUERTA PLACA 46



 MPP 46

 0,355 KG/M

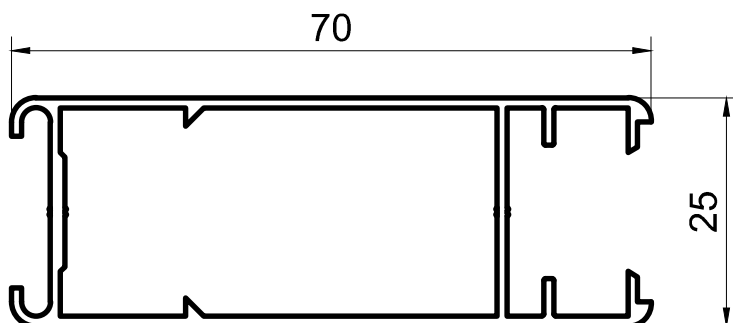
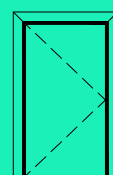
 X10: 22,000 KG

 6,20 M

PARANTE POSTIGÓN 25



 PP 25

 0,640 KG/M

 X6: 23,800 KG

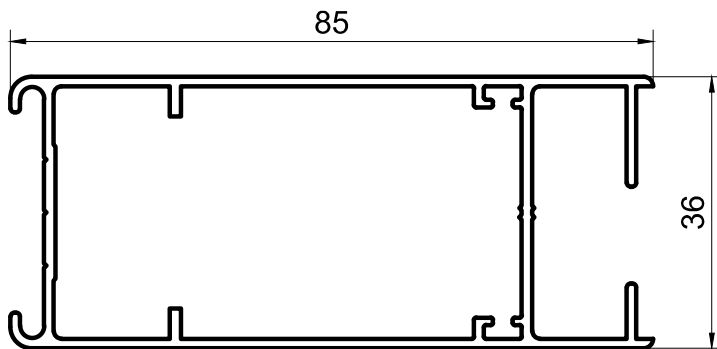
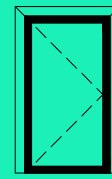
 6,20 M



PARANTE PUERTA 36 ARMADO A 45°



 PP 36

 0,980 KG/M

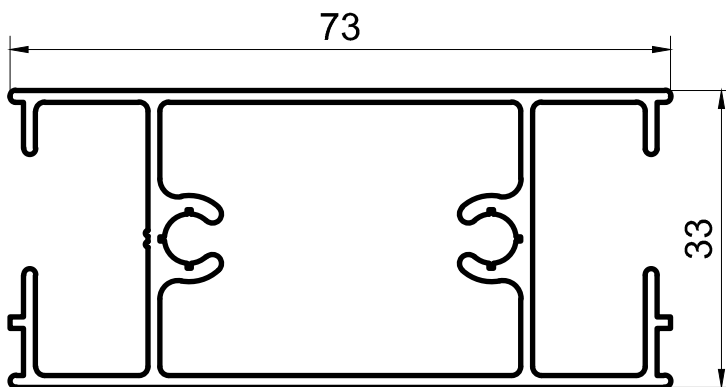
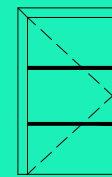
 X4: 24,300 KG

 6,20 M

TRAVESAÑO DE PUERTA 36



 TP 36

 1,045 KG/M

 X4: 25,300 KG

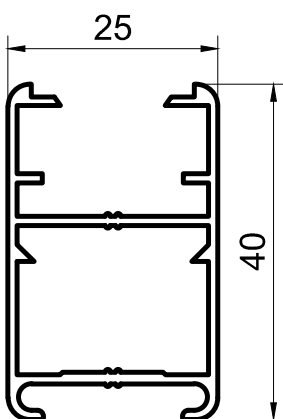
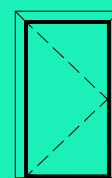
 6,05 M

PARANTE POSTIGÓN CHICO

 178

 0,464 KG/M

 X8: 23,000 KG

 6,20 M

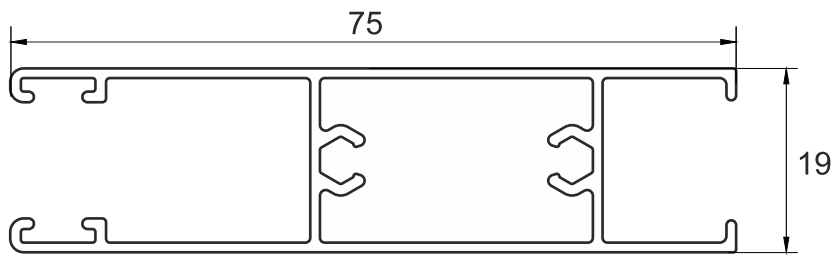
ZÓCALO ALTO PUERTA CORREDIZA



 144

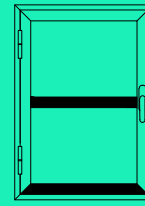

 0,618 KG/M

 X6: 22,400 KG

 6,05 M

MARCO DE ALTO TRÁNSITO

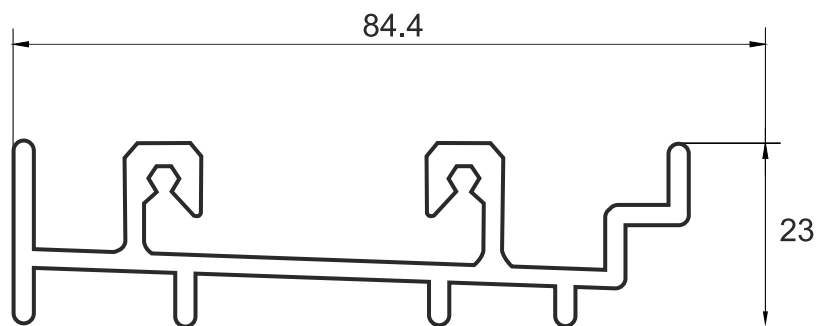

 117

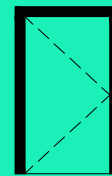

 1,066 KG/M

 X4: 25,800 KG

 6,05 M

MARCO PAÑO FIJO

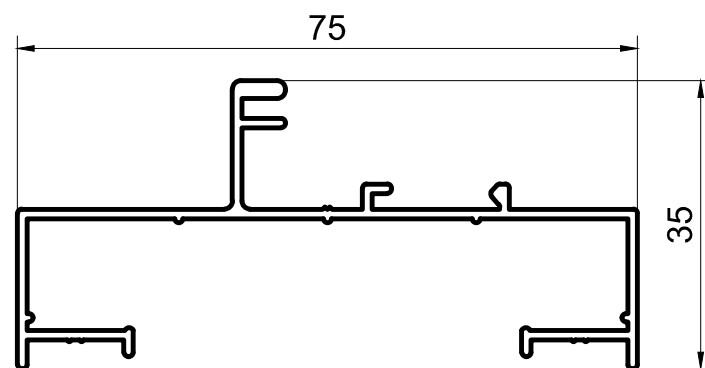

 107

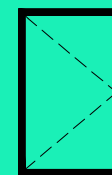

 0,524 KG/M

 X6: 19,000 KG

 6,05 M

CONTRAVIDRIO

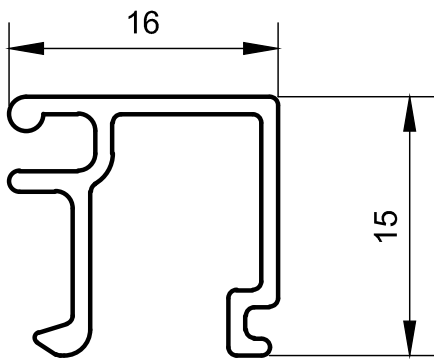

108



0,151 KG/M

X20: 18,300 KG

6,05 M

MARCO AIREADOR

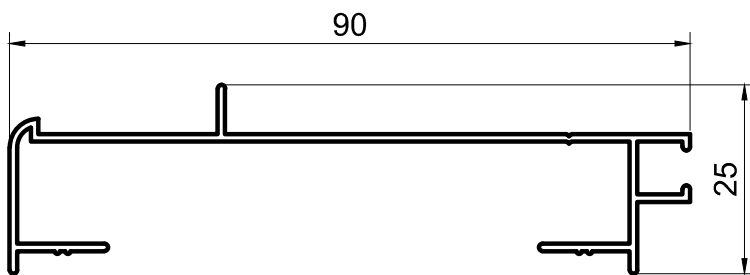

161

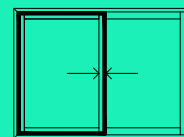

0,454 KG/M

X8: 22,000 KG

6,05 M

ESCUADRA LIVIANA

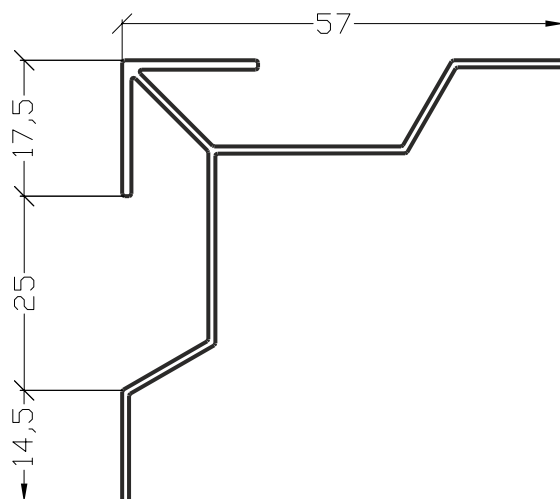

ESLI

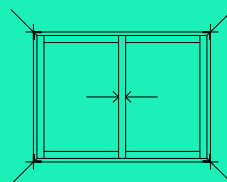

0,396 KG/M

X6: 14,400 KG

6,05 M

ESCUADRA INTERMEDIA

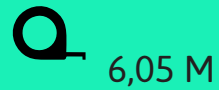
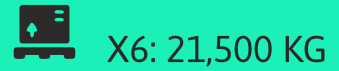
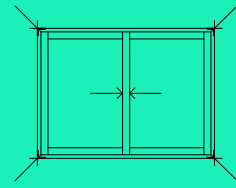
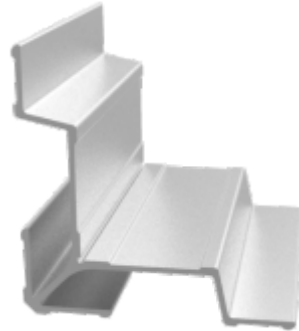
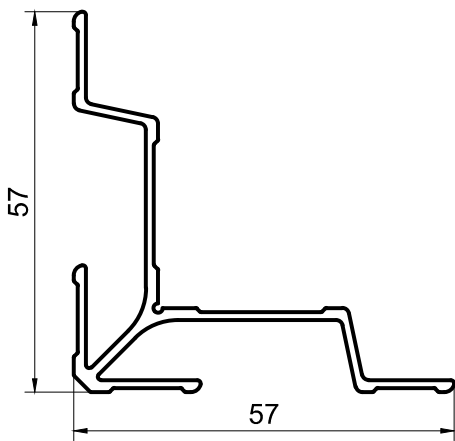

CENTRAL VIDRIO REPARTIDO

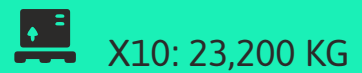
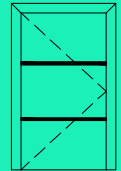
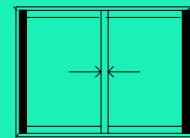
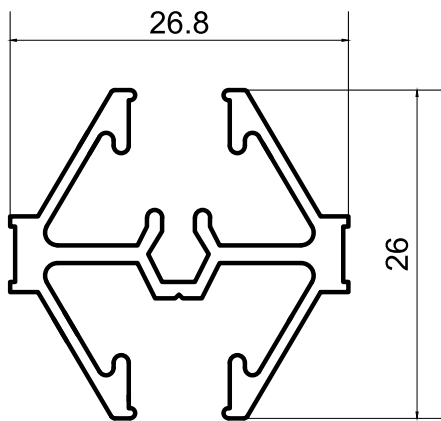

PERIMETRAL VIDRIO REPARTIDO

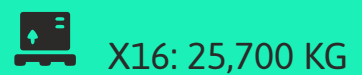
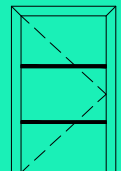
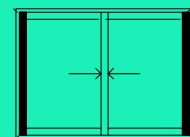
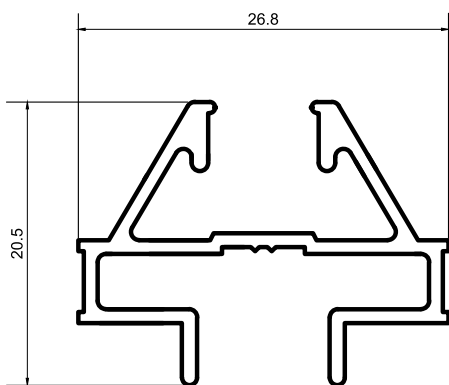



EXTRALUM

LÍNEA

E 90

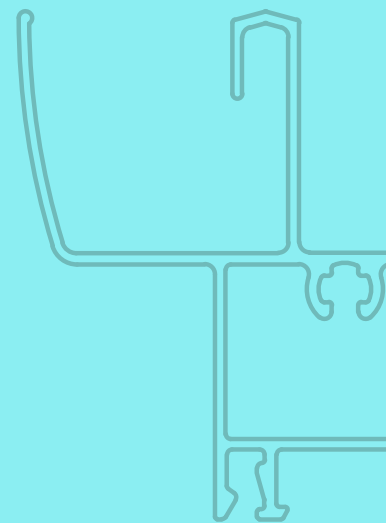

EXTRUSIÓN DE PERFILES DE ALUMINIO

UMBRAL DINTEL REFORZADO

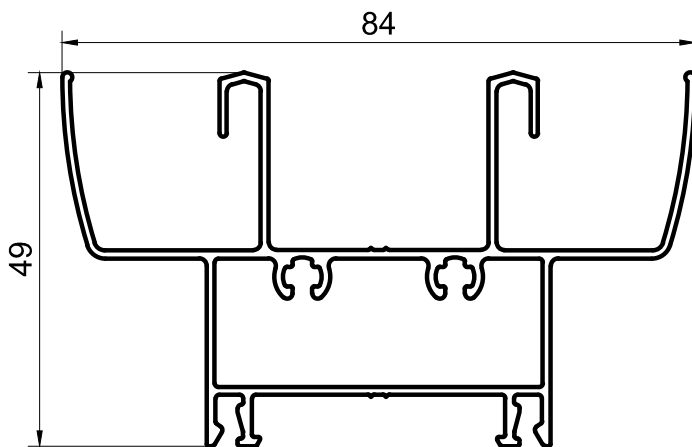

 6200P

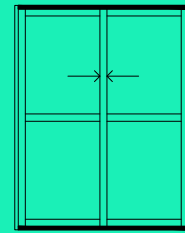

 1,266 KG/M

 X4: 31,400 KG

 6,20 M

JAMBA MARCO

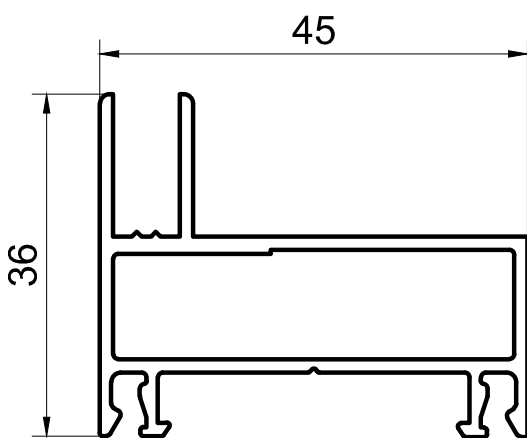

 6201

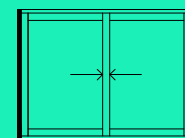

 0,670 KG/M

 X6: 24,900 KG

 6,20 M

PARANTE LATERAL SIMPLE

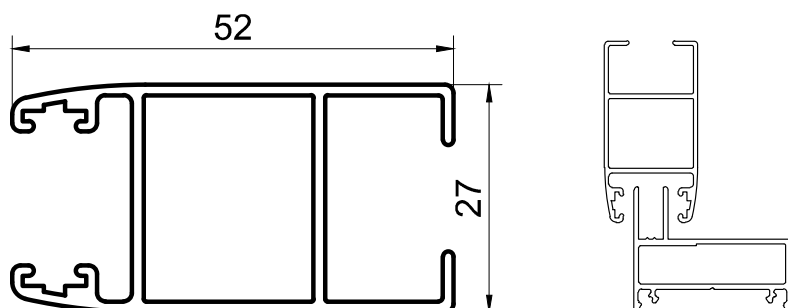

 6203

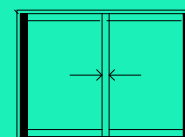



 0,700 KG/M

 X6: 26,000KG

 6,20 M

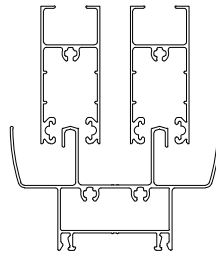
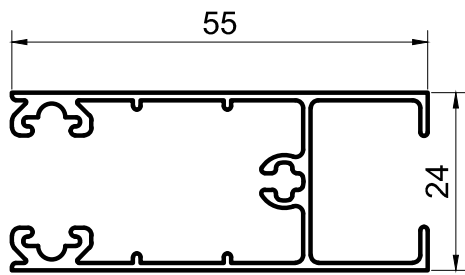
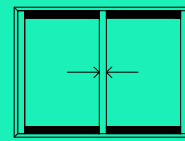
CABEZAL ZÓCALO SIMPLE



 6204

 0,700 KG/M

 X6: 26,000KG

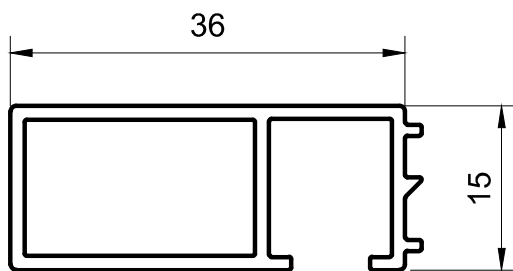
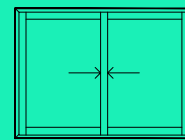
 6,20 M

PREMARCO



 6205

 0,361 KG/M

 X12: 26,900KG

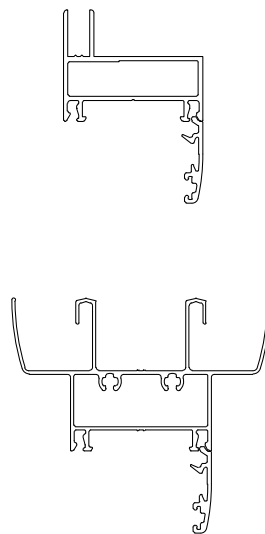
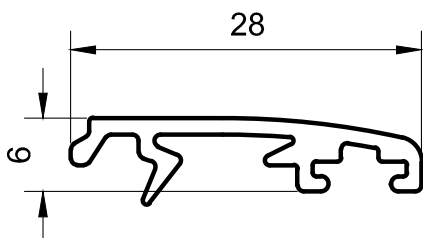
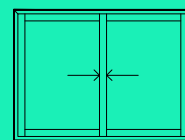
 6,20 M

TAPA JUNTAS



 6206

 0,182 KG/M

 X12: 13,600 KG

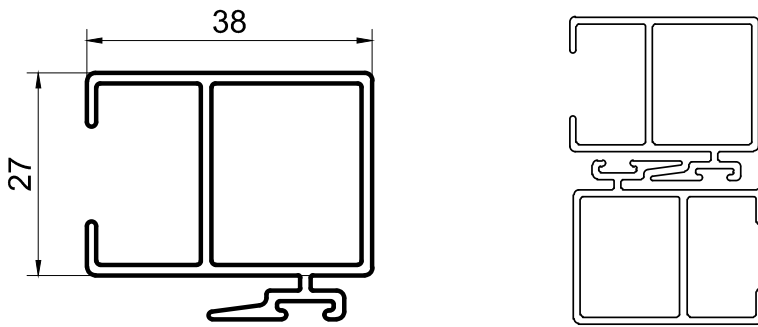
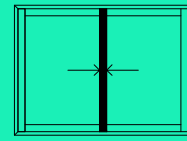
 6,20 M

PARANTE CENTRAL SIMPLE

 6207

 0,613 KG/M

 X6: 22,800 KG

 6,20 M

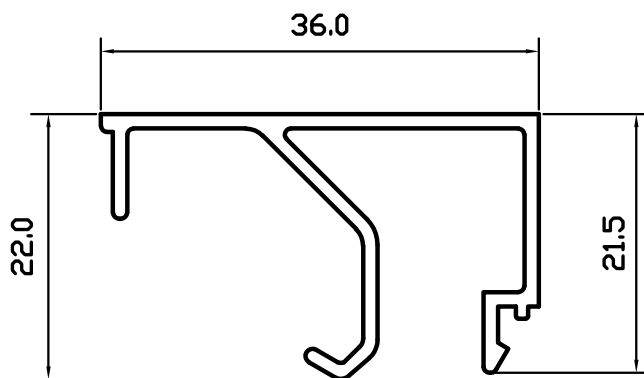
CONTRAVIDRIO 36MM



 6212

 0,316 KG/M

 X12: 23,500 KG

 6,20 M

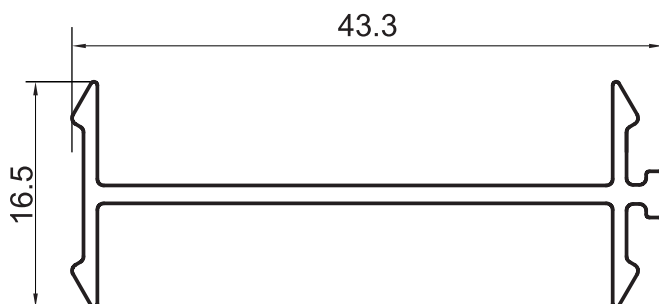
PERFIL DE ACOPLE SIMPLE



 6213

 0,248 KG/M

 X12: 18,500 KG

 6,20 M

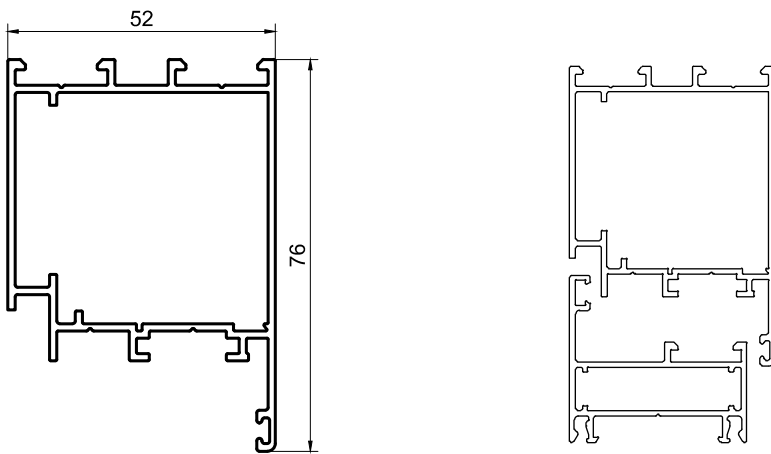
JAMBAS Y CABEZAL HOJA
PUERTA DE REBATIR.



 6214

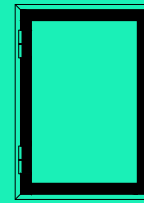

 1,085 KG/M

 X4: 26,900 KG

 6,20 M

HOJA VENTANA DE ABRIR
DOBLE CONTACTO/BANDEROLA.

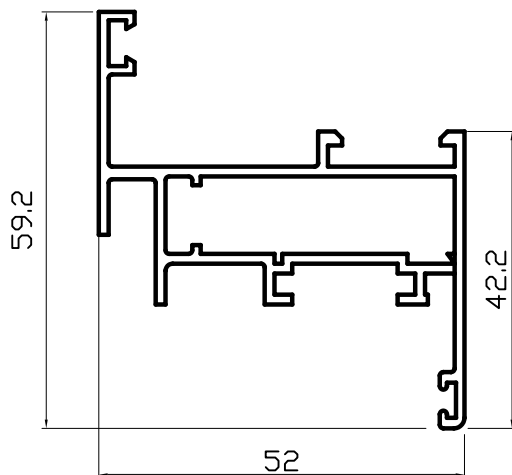

 6215

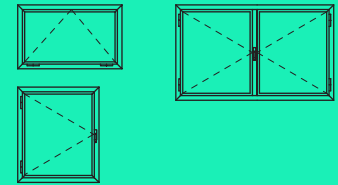

 0,864 KG/M

 X4: 21,400 KG

 6,20 M

MARCO VENT. DE ABRIR DC/BANDEROLA/
PUERTA REBATIR/VENTILUZ/PF RECTO.

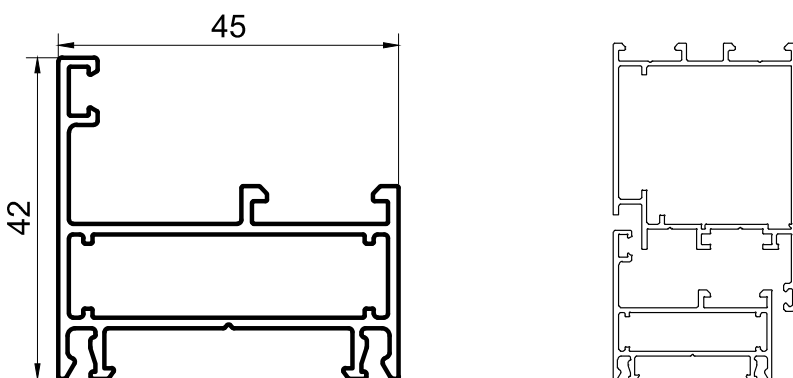

 6216

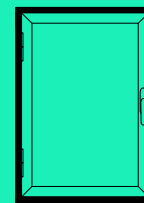

 0,724 KG/M

 X6: 26,900 KG

 6,20 M

CONTRAVIDRIO 29 MM

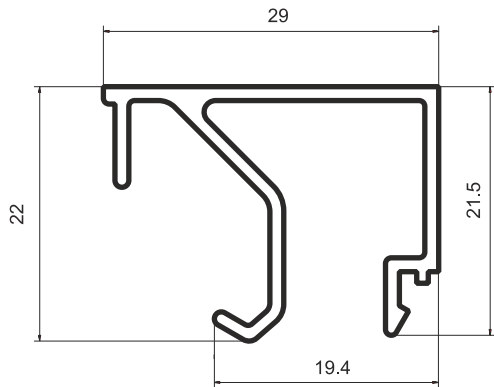

 6217

 0,294 KG/M

 X12: 22,000 KG

 6,20 M

TRAVESAÑO HOJA PUERTA DE REBATIR.

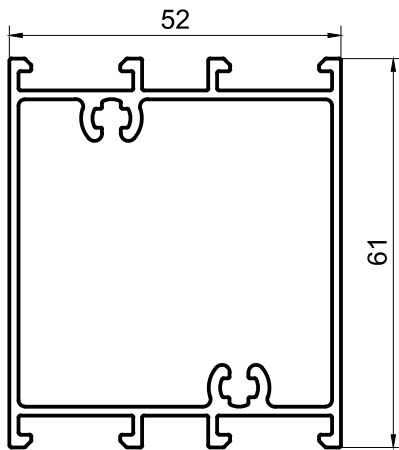

 6218

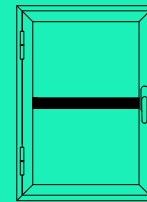

 1,150 KG/M

 X4: 28,500 KG

 6,20 M

CONTRAVIDRIO EXTERIOR PUERTA DE REBATIR.

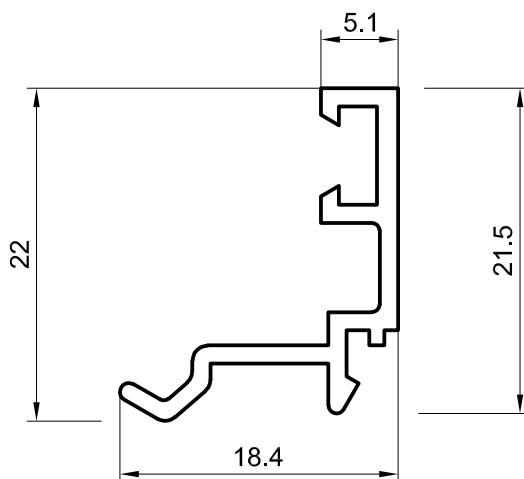

 6220

 0,173 KG/M

 X12: 12,800 KG

 6,20 M

ENCUENTRO CENTRAL VENTANA DE ABRIR
2 HOJAS DC/PTA. DE REBATIR

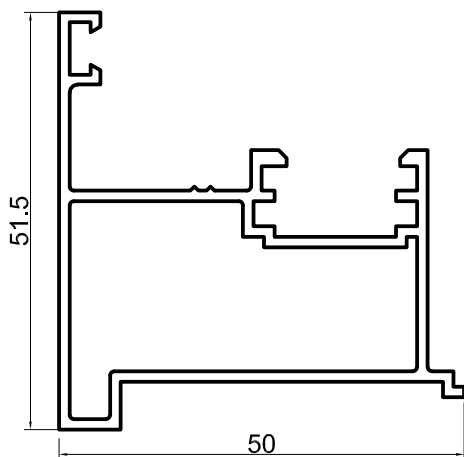

6224

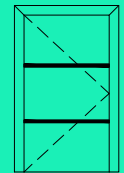
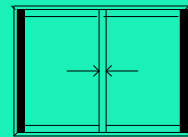

0,745 KG/M

X4: 18,500 KG

6,20 M

CONTRAVIDRIO RECTO DE 22MM.

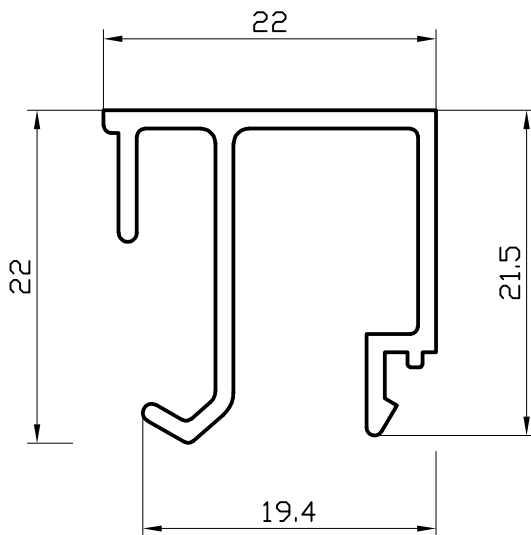

6225

0,257 KG/M

X12: 19,000 KG

6,20 M

CONTRAVIDRIO RECTO 15MM.

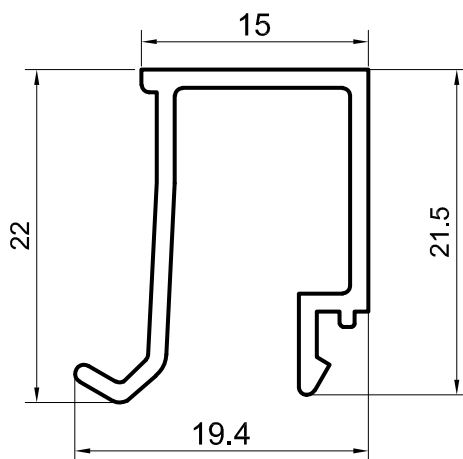

6226

0,211 KG/M

X12: 15,800 KG

6,20 M

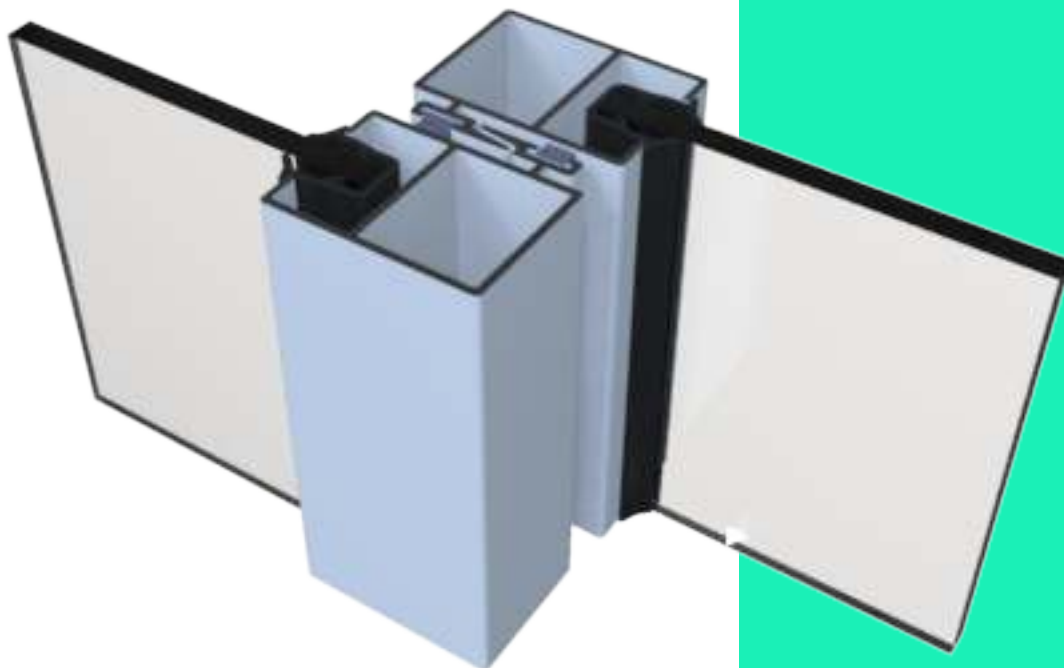
FORMA DE ENCUENTRO
ENTRE PERFILES CENTRAL

VINCULACIÓN DE PERFILES CON TAPA PLÁSTICA

REFERENCIAS:  CÓDIGO PESO POR BARRA CANTIDAD Y PESO POR PACK MEDIDA DE BARRA

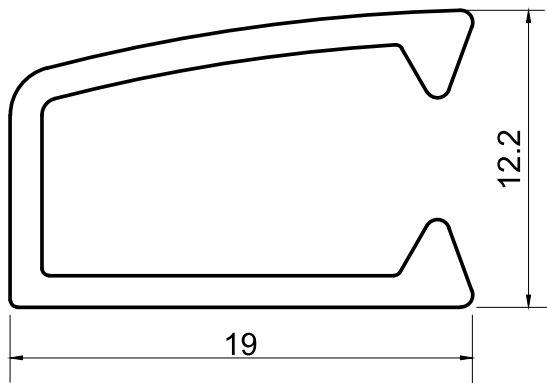
TOPE MOSQUITERO VENTANA Y
PUERTA CORREDIZA.
 6228

 0,178 KG/M

 X12: 13,200 KG

 6,20 M

PAÑO FIJO CURVO.

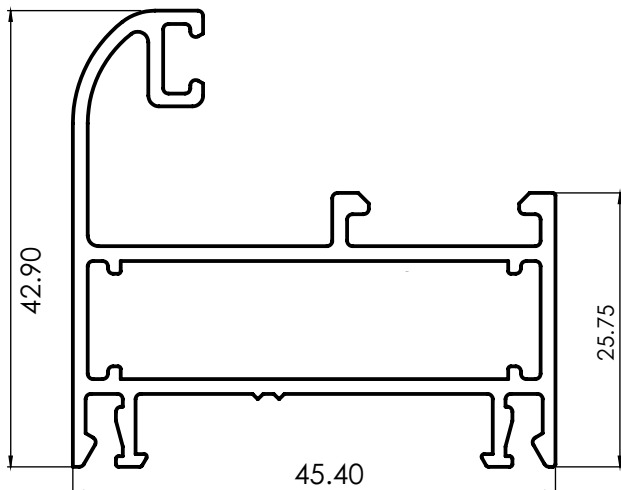

 6229

 0,767 KG/M

 X4: 19,000 KG

 6,20 M

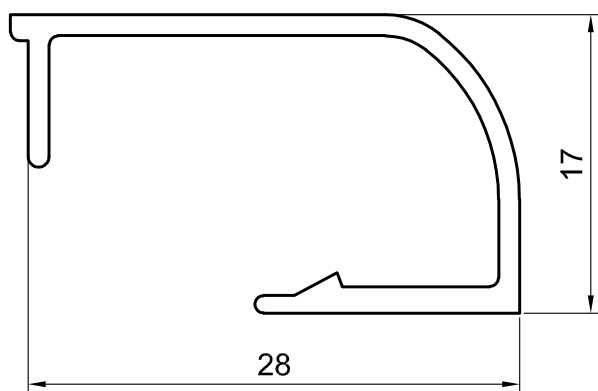
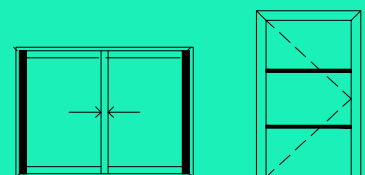
CONTRAVIDRIO CURVO 29MM

 6230

 0,213 KG/M

 X12: 15,800 KG

 6,20 M

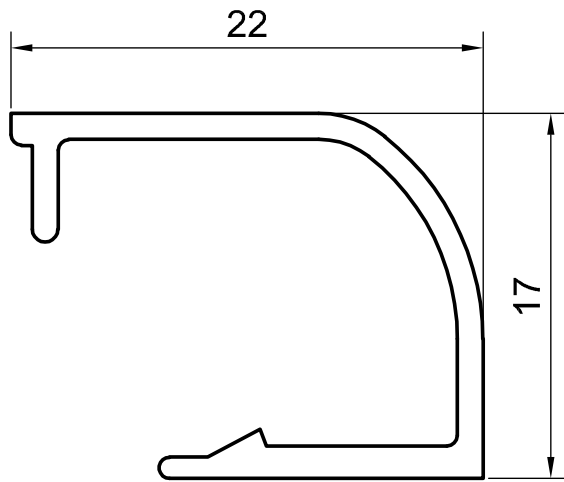
CONTRAVIDRIO CURVO 22MM



6232

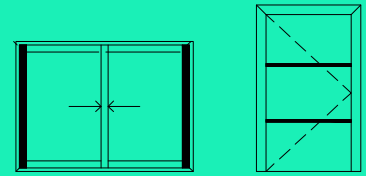

0,181 KG/M

X12: 13,500 KG

6,20 M

HOJA CURVA VENTANA DE ABRIR D.C./BANDEROLA.

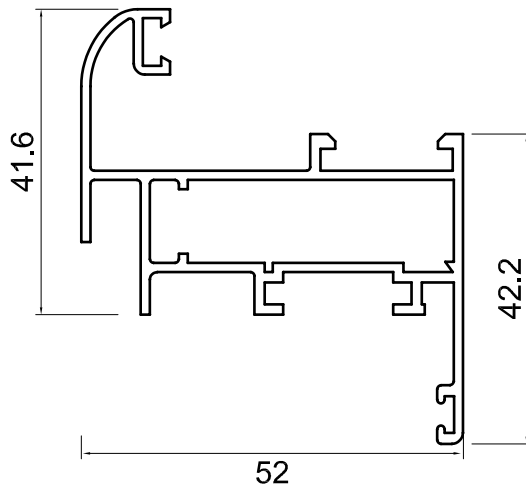

6235

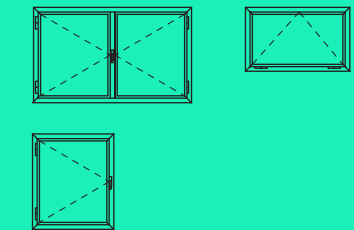

0,829 KG/M

X4: 20,600 KG

6,20 M

HOJA CURVA VENTILUZ

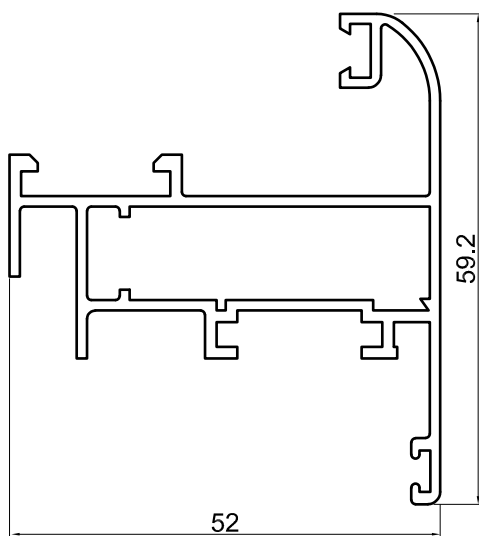

6236

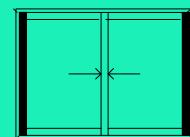



0,832 KG/M

X4: 20,600 KG

6,20 M

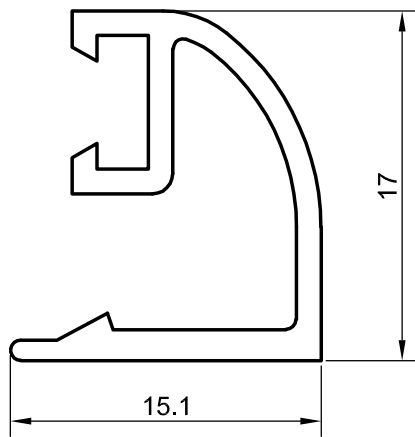
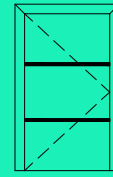
CONTRAVIDRIO CURVO EXTERIOR
PUERTA DE REBATIR



 6237

 0,175 KG/M

 X12: 13,000 KG

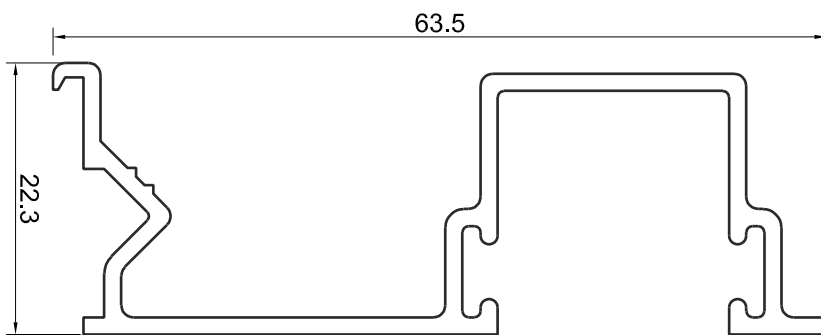
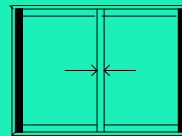
 6,20 M

GUÍA DE CORTINA COMÚN

 6243

 0,532 KG/M

 X8: 26,400 KG

 6,20 M

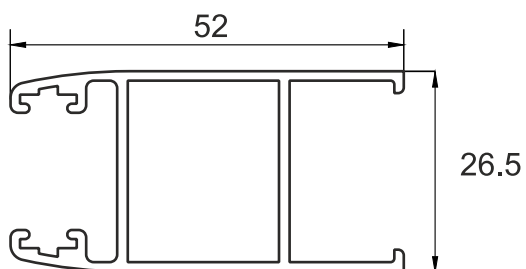
PARANTE LATERAL DE HOJA PARA DVH
VENTANA Y PUERTA CORREDIZA.



 6248

 0,621 KG/M

 X6: 23,100 KG

 6,20 M

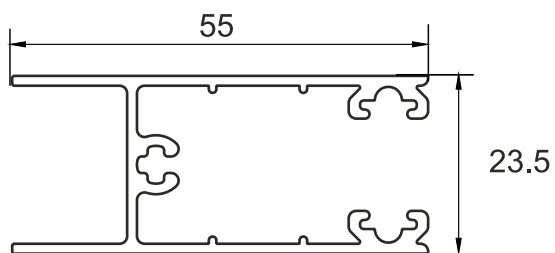
ZOCALO Y CABEZAL DE HOJA PARA DVH
VENTANA Y PUERTA CORREDIZA.



6249

0,645 KG/M

X6: 25,600 KG

6,20 M

PARANTE CENTRAL DE HOJA PARA DVH
VENTANA Y PUERTA CORREDIZA.

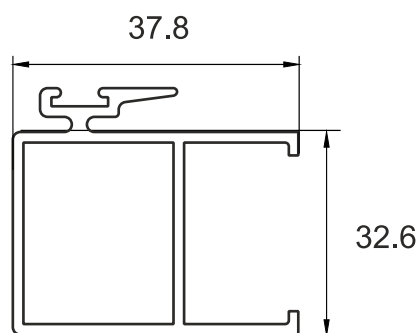

6250

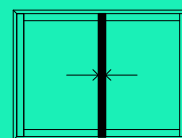

0,586 KG/M

X6: 21,800 KG

6,20 M

BASTIDOR MOSQUITERO.

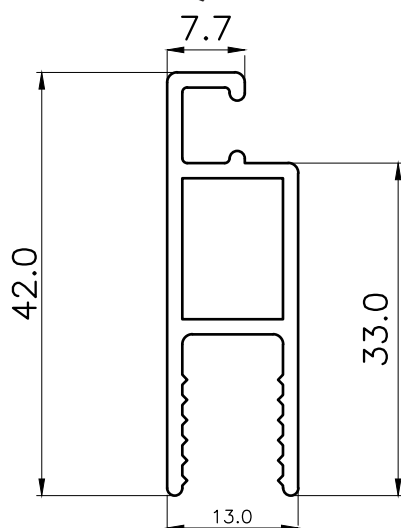



6255

0,427 KG/M

X10: 26,500 KG

6,20 M

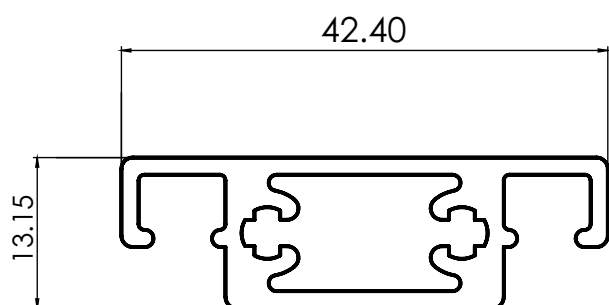
TRAVESAÑO MOSQUITERO.

 6256 0,543 KG/M X6: 20,200 KG 6,20 M

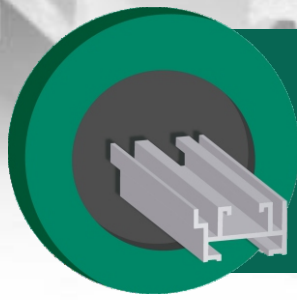

EXTRALUM

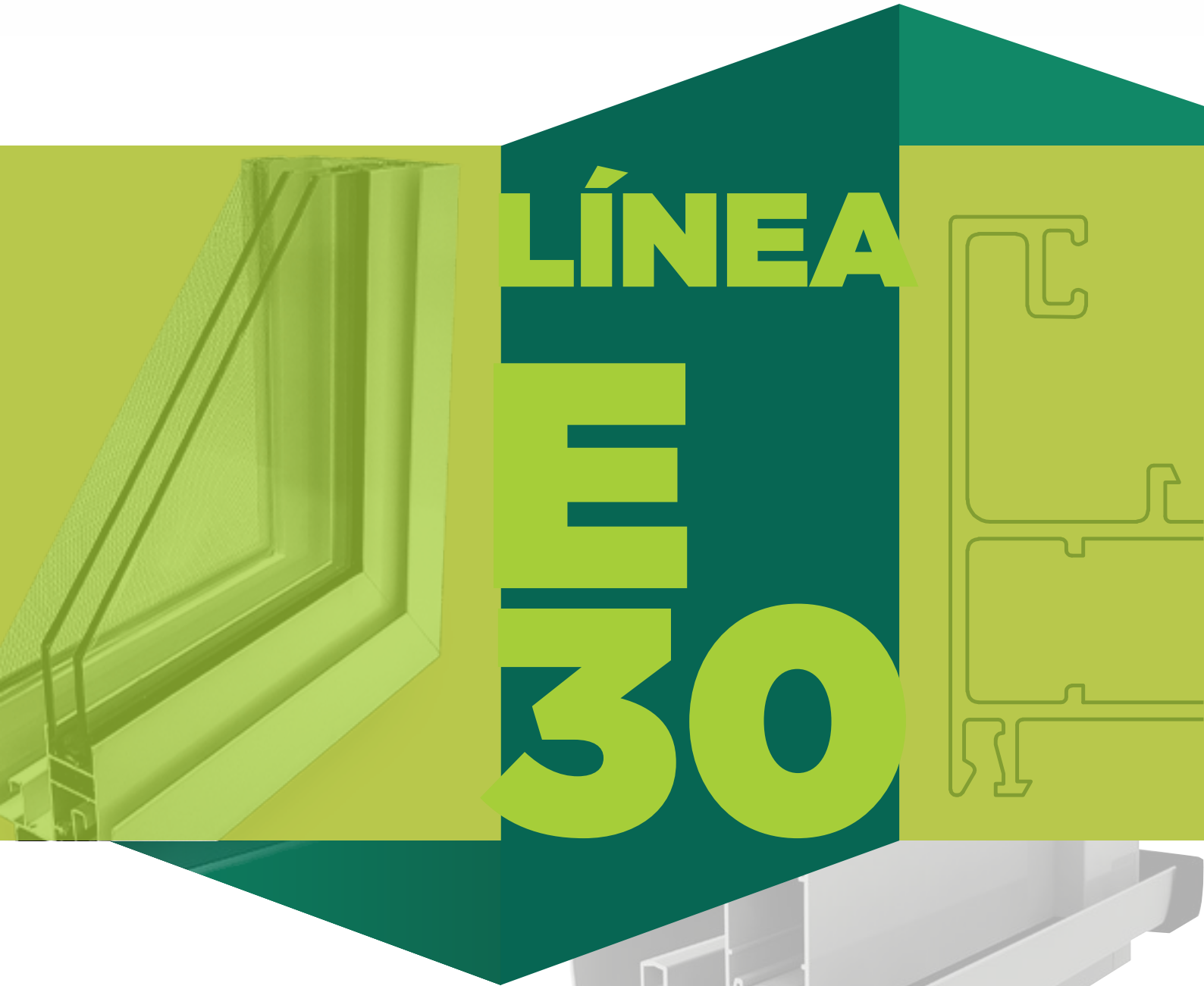



LÍNEA E 30

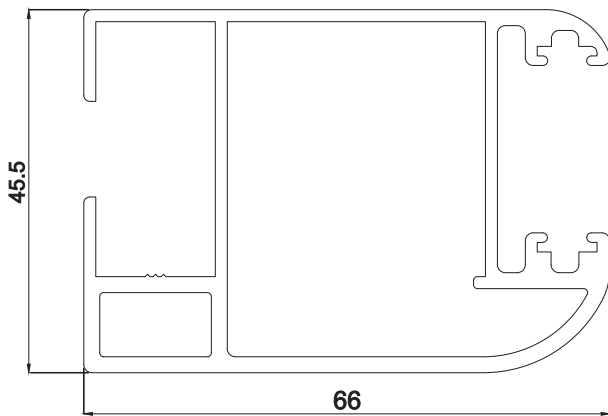

EXTRUSIÓN DE PERFILES DE ALUMINIO

PARANTE LATERAL CORREDIZA

 6034

 1,399 KG/M

 x2: 17,300 KG

 6,20 M

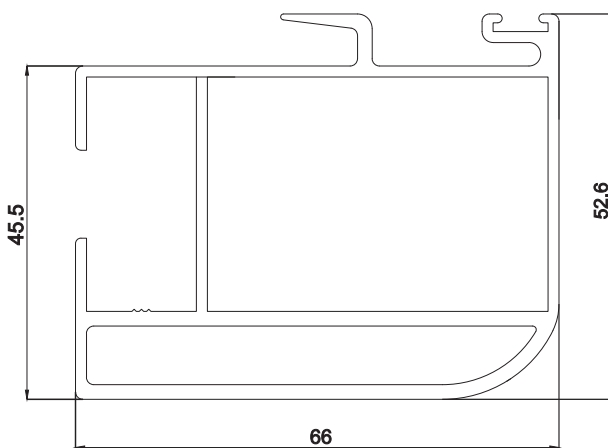
PARANTE CENTRAL CORREDIZA

 6035

 1,531 KG/M

 X2: 19,000 KG

 6,20 M

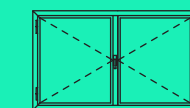
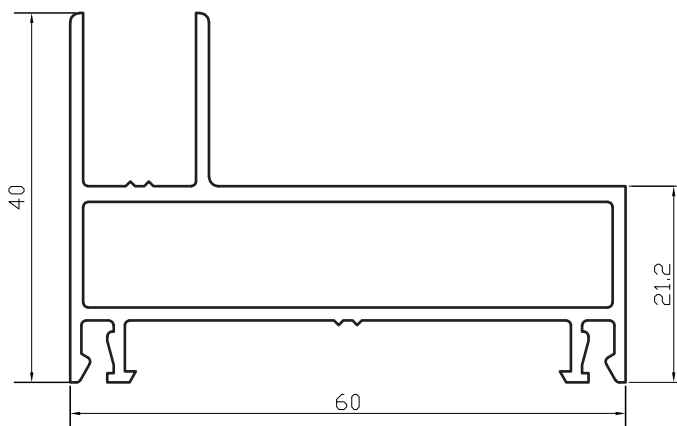
JAMBAS DE MARCO

 6036

 0,891 KG/M

 X4: 22,100 KG

 6,20 M

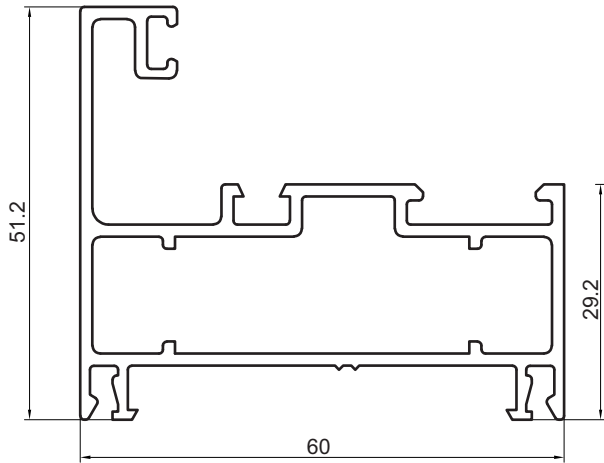
MARCO RECTO PAÑO FIJO Y VENTANA DE ABRIR.



6059

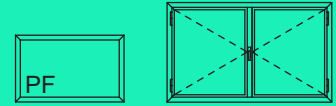

1,053 KG/M

X2: 13,100 KG

6,20 M

ZOCALO Y CABEZAL VENTANA CORREDIZA.

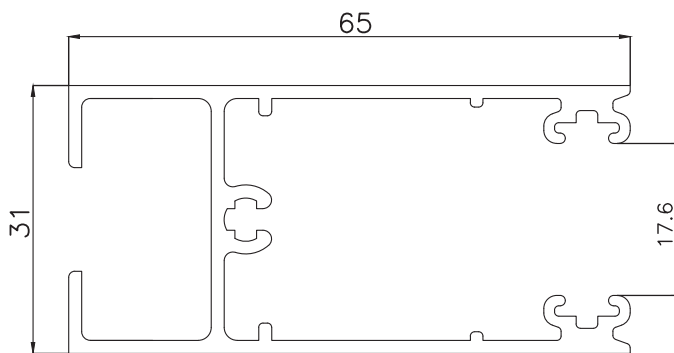

6061

0,926 KG/M

X4: 23,000 KG

6,20 M

PREMARCO.

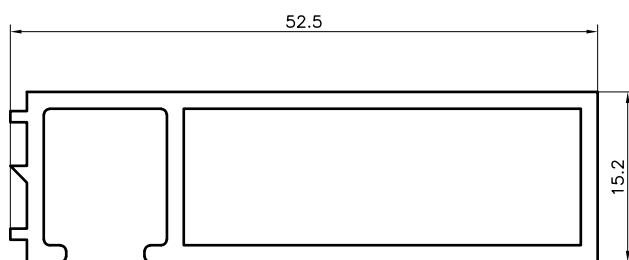

6066

0,545 KG/M

X5: 16,900 KG

6,20 M

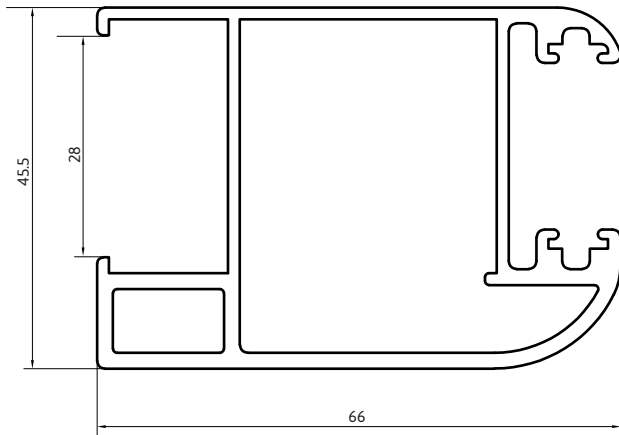
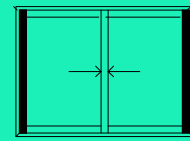

PARANTE LATERAL CORREDIZA PARA DVH.



 6071

 1,334 KG/M

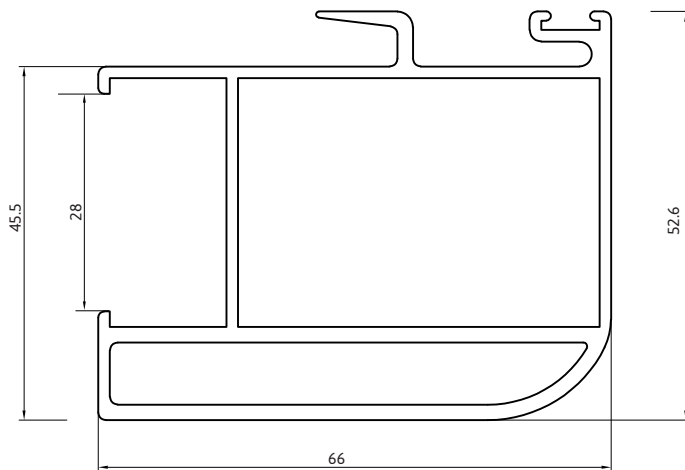
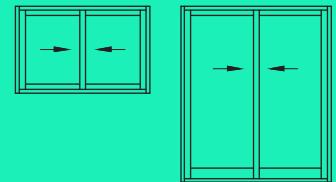
 X2: 16,500 KG

 6,20 M

PARANTE CENTRAL CORREDIZA PARA DVH.



 6072

 1,466 KG/M

 X2: 18,200 KG

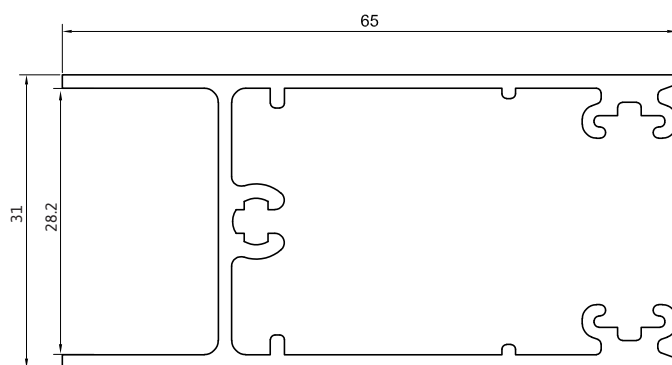
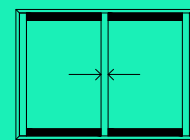
 6,20 M

ZÓCALO Y CABEZAL CORREDIZA PARA DVH.

 6073

 0,829 KG/M

 X4: 20,600 KG

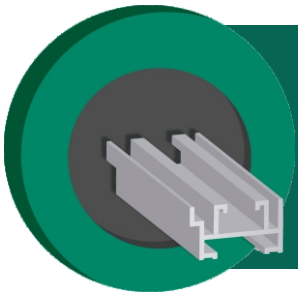
 6,20 M



EXTRALUM

CONTACTO

Dirección: Avenida de las Américas 1967
(S2121AOE) Pérez, Santa Fe
Teléfono: (0341) 4953993
E-mail: info@extralum.com.ar

VENTAS

Estefanía Sinquet
Teléfono: (0341) 153693888
E-mail: ventas@extralum.com.ar
Web: extralum.com.ar
IG: [@extralum_arg](https://www.instagram.com/extralum_arg)

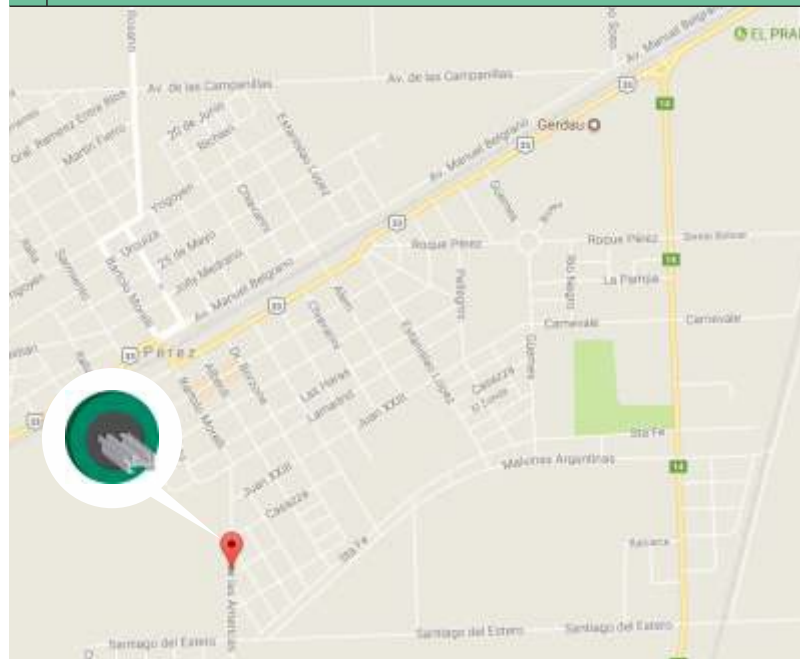

www.extralum.com.ar

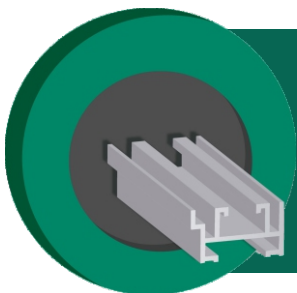

EXTRALUM